

36



LATHE CHUCKS

DIRECT MOUNTING 3-JAW AND 4-JAW

Type 3244 & Type 4344

D-1 Series Short Taper Spindle, Cam-Lock Nose

Standard Accuracy
Semi-Steel Body
Standard Scroll

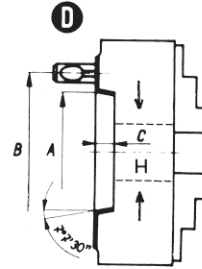
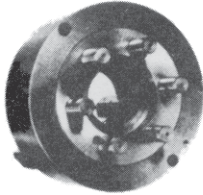

	A	B	C	No Pins	Dia Pins
4	63.513	82.6	13	3	16
6	106.375	133.4	16	6	22
8	139.719	171.4	18	6	25
11	196.869	235.0	20	6	30
15	285.775	330.2	21		

Bore Diameter "H"

3 Jaw	160	200	250	315	400
	42	55	76	103	
4 Jaw	38	50	65	80	100



Short Taper A-1 Spindle Nose

Standard Accuracy
Semi-Steel Body
Standard Scroll

Type 3214 & Type 4314

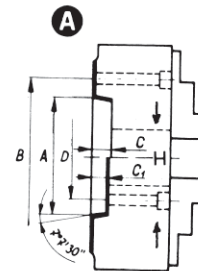

	A	B	C	C1	D
5	82.563	104.8	15	14.288	61.9
6	106.375	133.4	16	15.875	82.6
8	139.719	171.4	18	17.462	111.1
11	196.869	235	20	19.05	165.1
15	285.775	330.2	21	20.638	247.6



LATHE CHUCKS



Power Chucks Series 2405

Power Chucks with through hole in which wedge system of power transmission is incorporated prove their merits in everyday use. Their fundamental advantages are great load carrying capacity, durability and high clamping accuracy and repeatability.

Technical features:

- Manufactured from high grade alloy steel
- Mating surfaces of all parts hardened and ground
- Rigid construction
- Base jaws secured against throw-off
- Base jaws lubricated directly
- Front stop of piston in the cylinder, rear stop on spindle or adaptor plate

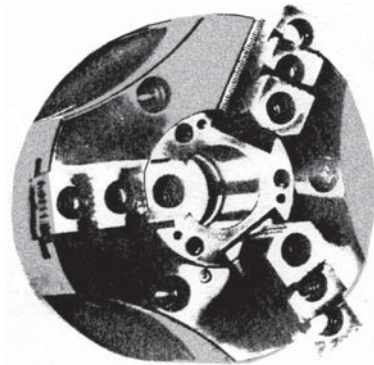

LIST OF SPARE PARTS FOR LATHE CHUCKS

A. Self-Centring

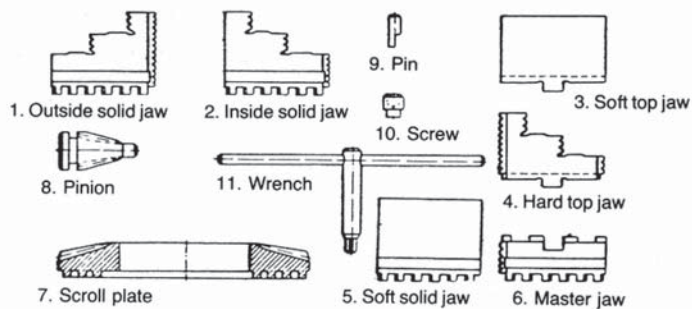

B. With independent Jaw Setting

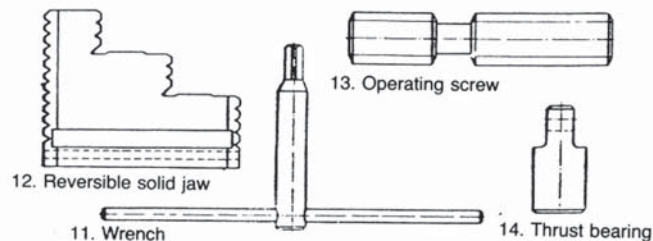

LATHE CHUCKS



PLAIN BACK SELF CENTREING
3 JAW + 4 JAW

Type 3204 & Type 3604

Finest quality Accuracy guaranteed

**Standard Accuracy
Semi-Steel Body**

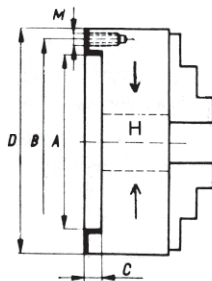

D	80	100	125	160	200	250	315	400	500	630	800
A	56	70	95	125	160	200	260	330	420	545	450
B	67	83	108	140	176	224	286	362	458	586	368.3
C	3	3	4	4	4	5	5	5	5	7	20
M	M6	M8	M8	M10	M10	M12	M16	M16	M16	M16	M24
H	16	20	32	42	55	76	103	136	190	252	320
Weight approx. (kg)	2	3	5	10	16	28	50	88	146	224	480

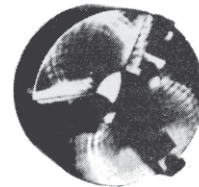

Type 4304

**4-JAW INDEPENDENT CHUCK
WITH PLAIN BACK**

**These chucks are made of high quality semi-steel.
Reversible jaws are hardened.**

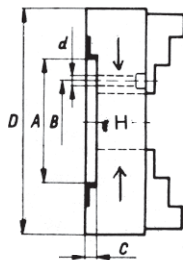

D	160	200	250	315	400	500	630	800
A	82.55	110	150	175	200	270	270	380
B	69.85	82.6	104.8	133.4	171.4	235	235	330.2
C	2.5	5	7	7	10	12	12	12
d	12	12	14	17.5	17.5	21	21	25
H	42	50	65	80	100	125	160	200
Weight approx. (kg)	4	16	25	43	70	125	184	350

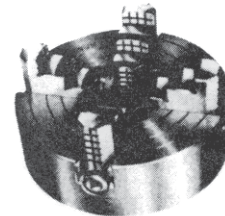

4 JAW IND CHUCKS NOW AVAILABLE UP TO 1250 mm